

Cleaning Technology DUNOS

Cleaning



KIESELMANN
FLUID PROCESS GROUP

The right Tools for perfect Hygiene

Besides safe base materials, hygienic plants and components are decisive for a safe product quality. KIESELMANN cleaning systems give no chance to germs and contaminations in tanks and vessels.

Matched to the different kinds of contaminations and to the vessel to be cleaned, static and rotating nozzles as well as jet cleaners are available. The design of the cleaners is characterized by minimized components and minimum clearance volume.

The performance of the cleaners can be perfectly adjusted to the cleaning requirements by means of customized jet geometries and/or nozzle number and rotation speed. In addition, all cleaners are fitted with an extremely effective self-cleaning function. The cleaning results become reproducible with our technology and thus support the validation of the cleaning processes. The almost loss-free flow of the cleaners disposing of an hygienic surface quality as well as the high-quality materials provide high efficiency. They help you to maximize the production and hygienic safety in your food production or in your process.

- ▶ FDA conform
- ▶ GMP conform
- ▶ EHEDG conform

Fields of Application

- ▶ Storage tanks
- ▶ Transport tanks
- ▶ Fermenting tanks
- ▶ Chemical synthesis Reactors
- ▶ Tubs
- ▶ Silos
- ▶ Barrels
- ▶ Mixers
- ▶ Stirrers
- ▶ Tuns
- ▶ Kegs
- ▶ Containers
- ▶ Cans
- ▶ Basins

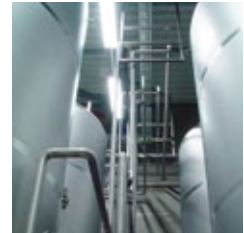

Selection of the Cleaner for your Process

The selection of the cleaner depends on the cleaning task. The appropriate nozzle fitting as well as the suitable material are decisive for the cleaning efficiency. The cleaning medium is another important step to manage your cleaning task. We help you to make the right decision.

- ▶ Analysis of the cleaning task
- ▶ Planning of the cleaning cycles
- ▶ Determination of the planned process
- ▶ Definition of the cleaning positions in the vessel
- ▶ Selection of the appropriate cleaner
- ▶ In co-operation with our partners, a recommendation for CIP chemicals can be given
- ▶ Upon customer's request
Cleaning tests with our mobile system
- ▶ Evaluation and documentation of the results with recommendation for your cleaning requirements

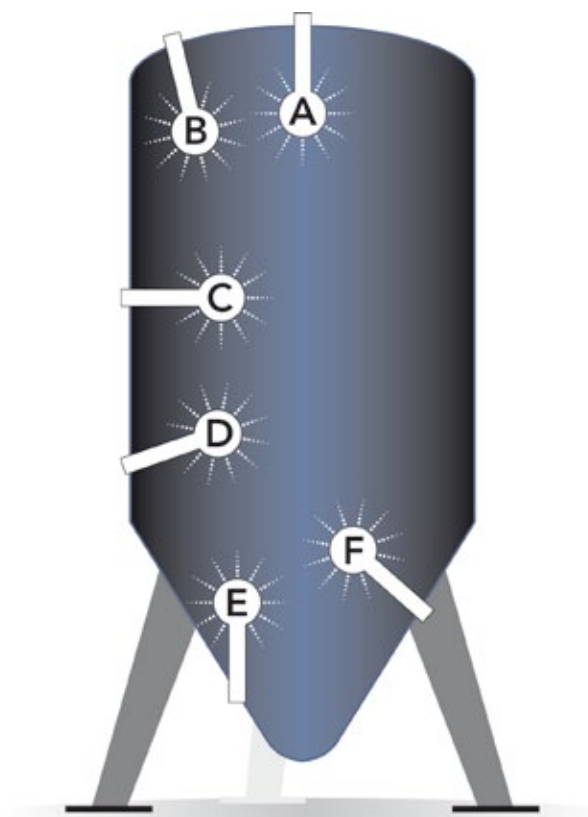

The KIESELMANN cleaners can be built into the tank in any position.

Static nozzles

Sometimes even a simple technique complies with the requirements of an application. However, a static nozzle does not equal to a static nozzle. We attach great importance to processing, surface quality and best possible design.

Our DUNOS_s offer and produce, despite their simplicity, efficient cleaning patterns on the surface. We don't leave the distribution of the cleaner to chance. We offer you standard as well as application-optimized solutions for an efficient cleaning.

- ▶ Hygienically perfect outer and inner design
- ▶ Stereoscopic cleaning image
90°, 180°, 270°, 330°
special images as an option
- ▶ Different standard nozzles
as an option, custom-designed
- ▶ Any fitting position

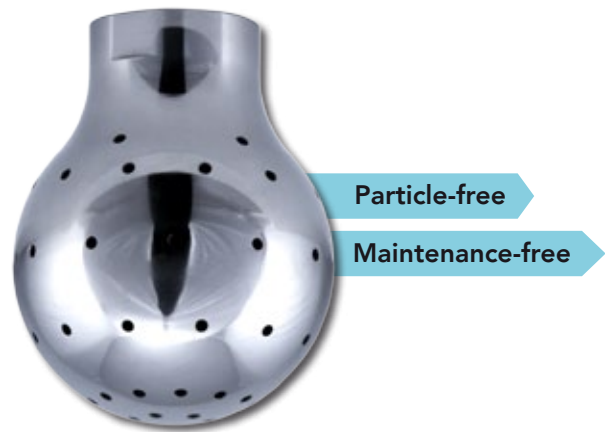

Particle-free

Maintenance-free

Jet pattern examples of the cleaner

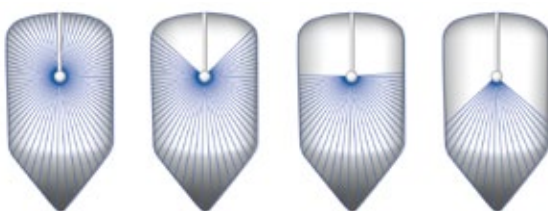

330°

270°

180°

90°

Depending on the DUNOS_s type, another jet image is produced on the vessel surface.

Spraying angle [°]	90°	180°	270°	330°
	Cleaning diameter [m]			
DUNOS _s 25	0.5–1.0	0.8–1.5	0.8–1.5	0.8–1.5
DUNOS _s 50	0.8–1.5	1.5–2.8	1.5–2.8	1.5–2.8
DUNOS _s 80	2.0–3.5	2.8–4.5	2.8–4.5	2.0–3.5

TECHNICAL DATA

Spraying diameter:	at 2 bar: 500–3500 mm
Pressure range:	1–6 bar
Connections:	Thread, split-pin, welding end, customer specific
Operating temperature:	5–150° C
Materials:	1.4404 Special materials (optional): 1.4435, PTFE, Hastelloy
Surfaces:	Ra ≤ 0.8 µm
Certificates:	ATEX, Werkstoffzeugnis

Rotating surge cleaners

The cleaning and washing effect resp. is produced by the optimal distribution of the mass. The nozzle wets the complete surface within a few seconds by means of rotation.

Owing to the liquid storage, an excellent stability and a minimum quantity of particles is guaranteed. We proved this on the test bench in 1000 h lasting fatigue and endurance tests.

- ▶ Hygienic outer and inner design
- ▶ Loss-reduced flow
- ▶ Optimizable flow values
- ▶ Compact design with a minimum of components
- ▶ Stereoscopic cleaning image
180°, 270°, 360°
Special images as an option
- ▶ Nozzles depending on type, with slot as an option, custom-designed optimization
- ▶ Any fitting position, fix mounting or mobile operation possible

Jet pattern examples of the cleaner

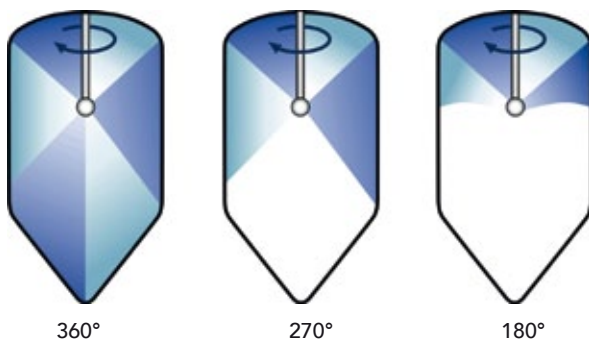

Depending on the geometric arrangement of the fan-jet, the required spraying image is produced on the vessel surface.



	15	32	60	90
G	1/8"	3/8"	3/4"/1"	2"
JD	10.1	18.2	28.2/29.2/34.2	52.2
H	28–33	49	86–100	125–140
K	15.8	31.8	59.8	94.8

*all data in mm unless otherwise noted

TECHNICAL DATA				
Spraying diameter:	at 2 bar: 700–3500 mm			
Pressure range:	recommended: 2–4 bar			
Installation opening:	R 15	R 32	R 60	R 90
	min. 16 mm	min. 32 mm	min. 60 mm	min. 90 mm
Connections:	Thread, split-pin customer-specific			
Operating temperatur:	5–95° C			
Materials:	1.4404 Special materials (optional): 1.4435, 1.4571, PTFE, Hastelloy			
Surfaces:	Ra ≤ 0.8 µm			
Certificates:	ATEX, material certificate			

Rotating nozzle spraying head

The DUNOS_{RB} cleaners, such as the DUNOS_O series, are hydraulically driven over a turbine. The nozzle achieves a high cleaning effect, even in case of very low mass application.

The spraying image, which can be selectively optimized for your process, provides results you had to do without till now. We will create a cleaner for you which will meet your requirements.

The special strength of this cleaner arises wherever you have to achieve much with small quantities. Particularly when an agitating vessel has to be rinsed from batch to batch.



- ▶ **Spraying image can be individually designed**
- ▶ **Flow can be individually planned**
- ▶ **High production quality**
- ▶ **Minimum clearance volume**
- ▶ **Option:**
 - **Rotation monitoring**
 - **Inlet lance with connection to vessel**

TECHNICAL DATA

Spraying diameter:	at 2 bar up to 6000 mm
Pressure range:	1–15 bar
Installation opening:	min. 50 mm
Connections:	G ¾ inner thread customer-specific
Operating temperature:	5–95° C
Materials:	1.4404 Special materials (optional): 1.4435, 1.4571, PTFE, Hastelloy
Surfaces:	Ra ≤ 0.8 µm
Certificates:	ATEX, material certificate

Strong cleaner

The DUNOS_{RN} is a fluid-driven rotational cleaner. The nozzle achieves the complete surface to be wetted with each rotation. The spraying image can be individually designed. The strength of the cleaner is its controlled spraying.

The kinetic energy of the spraying pattern is even able to flush out solid matters on and in a spiral movement, as this is necessary for cleaning of a whirlpool for instance.

- ▶ Fluid-driven rotational cleaner
- ▶ Can transport solid matters
- ▶ Complete wetting of the surface to be wetted per revolution
- ▶ Spraying image can be individually designed
- ▶ Minimum clearance volume
- ▶ Option:
 - Rotation monitoring
 - Inlet lance with connection to vessel



TECHNICAL DATA	
Spraying diameter:	at 2 bar up to 7000 mm
Pressure range:	3–15 bar
Installation opening:	min. 125 mm
Connections:	G 1 ½ inner thread customer-specific
Number of nozzles:	4–32 nozzles, Ø 2–8 mm
Operating temperature:	5–95° C
Materials:	1.4404, PEEK, PTFE Special materials upon request
Surfaces:	Ra ≤ 0.8 µm
Certificates:	ATEX, material certificate

Three-dimensional cleaning

The cleaners of the DUNOS_o series help to remove incrustations and critical deposits in a strong, quick and reliable way. Tailored to your requirements, you achieve both an effective and efficient removal of all residues. This is rendered possible by the selection of the nozzle fitting as well as by the range of the operating pressures. The cleaner even reaches small and angled geometries and apparatus areas which a conventional rotational cleaner must give in.

DUNOS_o series for results reproduceable at any time.

- ▶ Economical and ecologically friendly at the same time owing to minimization of the used quantities, logistic, waste and disposal costs
- ▶ Integrated self-cleaning during operation
- ▶ Driven by the medium.
Extremely low pressure losses
- ▶ Position of the drive of the medium possible at the head as well as alternative drives outside the vessel
- ▶ Any fitting position, fix mounting or mobile application possible as an option
- ▶ Long-life, low-maintenance design
- ▶ Simple maintenance
- ▶ Use of high-quality materials
- ▶ Optimized flow of all inner parts



Jet pattern examples of DUNOS_o

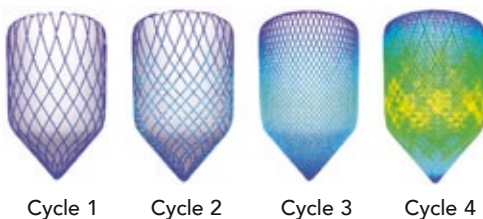

The complete inner surface is cleaned after the first cycle. Any further cycle produces a closer meshed cleaning image and thus a more intensive cleaning.

TECHNICAL DATA

Spraying diameter:	at 2 bar up to 10000 mm
Pressure range:	1–15 bar
Installation opening:	min. 70 mm
Connections:	G ¾ inner thread
Operating temperature:	5–95° C
Materials:	1.4404 Special materials (optional): 1.4435, 1.4571, Hastelloy
Surfaces:	Ra ≤ 0.8 µm
Certificates:	ATEX, material certificate, further certificates upon request

Three-dimensional cleaning

The DUNOS_o 90 is the large version in the DUNOS_o series. This machine is required when more kinetic energy over a larger spraying distance is necessary. Nevertheless, its consumption is economical. Large fermenting and storage tanks are the primary range of application. But also spray towers and large synthesis reactors benefit from this productivity.

You achieve brilliant qualitative and economical results with the DUNOS_o series.

- ▶ Economical and ecologically friendly at the same time owing to minimization of the used quantities, logistic, waste and disposal costs
- ▶ Integrated self-cleaning during operation
- ▶ Driven by the medium.
Extremely low pressure losses
- ▶ Position of the drive of the medium possible at the head as well as alternative drives outside the vessel
- ▶ Any fitting position, fix mounting or mobile application possible as an option
- ▶ Long-life, low-maintenance design
- ▶ Simple maintenance
- ▶ Use of high-quality materials
- ▶ Optimized flow of all inner parts

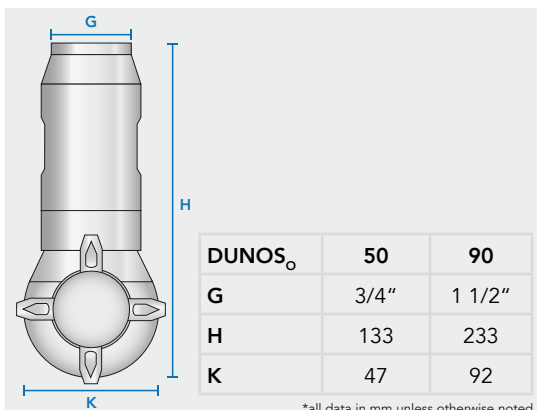

TECHNICAL DATA

Spraying diameter:	at 2 bar up to 14000 mm
Pressure range:	1–15 bar
Installation opening:	min. 130 mm
Connections:	G 1 1/2 inner thread
Operating temperature:	5–95° C
Materials:	1.4404 Special materials (optional): 1.4435, 1.4571, Hastelloy
Surfaces:	Ra ≤ 0.8 µm
Certificates:	ATEX, material certificate, further certificates upon request

Rotating surge cleaners

Even the application of steels of highest quality is not uncritical in a hydrochloric atmosphere or ambience. As soon as the temperature rises, in addition to the concentration, you will face an increased abrasion and/or even the destruction of the material. The carry-over of heavy metals into the product may be one of the consequences.

We recommend the cleaners of the DUNOS_R series which can be produced of different plastics, for such applications. These cleaners possess the same properties and capacities as the series made of metal. But these are suitable for extremely aggressive mediums causing pitting.

The DUNOS_R series made of e.g. glass-fibre reinforced PTFE, raises thus the bar for the cleanliness of your products both in an aqueous ambience and in a production environment where organic solvents are used.

- ▶ Selection of different dimensions for the adaptation to available pressure and flow rates of your transport systems
- ▶ Made of plastic for very corrosive hydrochloric mediums
- ▶ Standard cleaning images 180°, 270°, 360°
special images optional
- ▶ Consist of 3 individual components only
- ▶ Self-cleaning
- ▶ Optimized supporting tubes made of tantalum available
- ▶ Design with minimized friction
- ▶ Any fitting position, fix or mobile mounting possible



	15	32	60	90
G	1/8"	3/8"	3/4"/1"	2"
JD	10.1	18.2	28.2/29.2/34.2	52.2
H	28-33	49	86-100	125-140
K	15.8	31.8	59.8	94.8

* all data in mm unless otherwise noted

TECHNICAL DATA

Spraying diameter:	at 2 bar: 600–3500 mm								
Pressure range:	recommended: 2–4 bar								
Installation opening:	<table border="1"> <thead> <tr> <th>R 15</th> <th>R 32</th> <th>R 60</th> <th>R 90</th> </tr> </thead> <tbody> <tr> <td>min. 16 mm</td> <td>min. 32 mm</td> <td>min. 60 mm</td> <td>min. 90 mm</td> </tr> </tbody> </table>	R 15	R 32	R 60	R 90	min. 16 mm	min. 32 mm	min. 60 mm	min. 90 mm
R 15	R 32	R 60	R 90						
min. 16 mm	min. 32 mm	min. 60 mm	min. 90 mm						
Connections:	Thread, split-pin customer-specific								
Operating temperatur:	5–95° C								
Materials:	PTFE/Glass fibre 25 % PTFE/Carbon conductive PTFE pure PEEK/PTFE 10 %								
Surfaces:	Ra ≤ 0.8 µm								
Certificates:	ATEX, material certificate								

Interior cleaning for packages and containers

You clean packages and transport containers..

- for due disposal?
- for reuse?
- for cleaning of containers for the storage and transport of different products?

You need/wish a simple and cheap system for this purpose?

- We develop and furnish a customized module solution.
- Thanks to positioning aids, telescopic systems as well as automation, cleaning will be made easier for your staff.
- For an increase in safety, hygiene as well as the prevention of costs by minimizing the costs for labour time and material consumption.

- ▶ For a lost cleaning
- ▶ For cycle cleaning, fitting of mobile pump-buffer tank module possible
- ▶ Automatic dosing upon request
Cleaner without external premixing
- ▶ Agitation heated or unheated
- ▶ Spraying lance for simplified external cleaning/decontamination
- ▶ Control optionally with time relay or with programmable SPS
- ▶ Realizable for all our cleaners,
quick change of cleaners possible
- ▶ Optionally nozzle drive, fluid- or motor-driven
 - Fluid drive working pressures up to 25 bar
 - Motor drive working pressures up to 70 bar
- ▶ Fix mounting or mobile application possible



Rotating surge cleaner – validateable

The DUNOS_{R-VAL} consist of a combination of surge cleaner and wireless speed monitoring. The rotating cleaning head gives a signal directly to the monitoring electronics mounted.

In addition to the monitoring of rotation, i.e. the pure monitoring of the function, this device simultaneously enables the monitoring of the minimum speed relevant for the process.

The visualization of the function of the cleaner is made for the operators over a LED display. The rotation speed dependent signal can be monitored with an interface by a higher-level control, such as a process control system, and used as a release signal.

- ▶ **Proof of function visible from the outside over LED display**
- ▶ **Interface for higher-level control**
- ▶ **Programmable monitoring of the minimum and set rotation speed**
- ▶ **Non-contact recording of the function directly at the rotating nozzle head**



TECHNICAL DATA	
Spraying diameter:	at 2 bar: 500–5000 mm
Pressure range:	2–6 bar
Connections:	Thread, split-pin, customer specific
Operating temperature:	5–95° C
Materials:	1.4404 Special materials (optional): 1.4435, 1.4571, PTFE, Hastelloy
Surfaces:	Ra ≤ 0.8 µm
Certificates:	ATEX, Werkstoffzeugnis

Jet monitoring

The DWD sensor monitors the irregular jet of the cleaners of series DUNOS_o 50 and DUNOS_o 90. The sensor is positioned in the mounting flange of the jet cleaner, directly and without separately necessary connecting piece.

The visualization of the correct function of the cleaner is made for the operators over a LED display.

The signal can be monitored with an interface by a higher-level control, such as a process control system, and used as a release signal.

- ▶ Proof of function visible from the outside over LED display
- ▶ Integrated interface for higher-level control systems
- ▶ Programmable pulse recognition



How we can support you:

- If costs must be reduced. With elaboration of a detailed process analysis regarding effectiveness and efficiency of existing cleaning processes.
- If unsatisfactory results lead again and again to subsequent cleaning and delays.
- When a new plant is designed, cleaning can be already taken into consideration.
- If cleaning of old machines must be optimized.
- If there aren't any free resources in the own company for these demanding tasks.

- ▶ **Stabilization of unstable cleaning processes as well as streamlining of existing cleaning processes**
- ▶ **Reproduceable and thus valid processes**
- ▶ **Prevention of expensive rework**
- ▶ **Cost saving instead of cost explosion by detailed payback calculation**

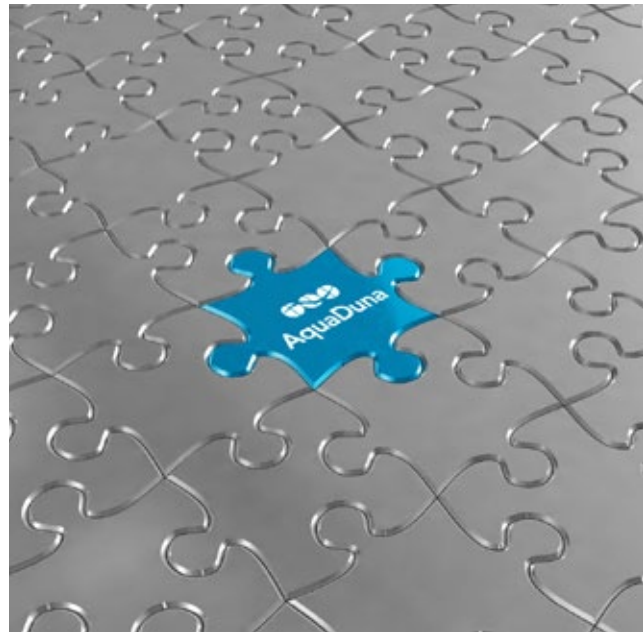

Along with the practical experience of our staff, we support our customers in a comprehensive, solution-oriented and efficient way. Of course, with our products as well, which can be modified for specific requirements, thanks to in-house production.

So we support our customers to avoid dissipation and follow-up costs. As far as our experience goes, the profitability of the processes is increased and not charged with additional costs, as far as our experience goes.

We don't want to produce costs and additional complexity, but we want to effect the converse.

We'd be pleased to inform you personally.

For your advantage - The FLUID PROCESS GROUP

The FLUID PROCESS GROUP is the association of companies incorporated by the KIESELMANN GmbH. Through this broad competency network we can optimize our synergies to realize complex projects – gladly acting as General Contractor – with resulting advantages for the client.



Ferdinand-von-Steinbeis-Ring 31
75447 Sternenfels, Germany
Telefon +49 (0)70 45 204 98-0
Fax +49 (0)70 45 204 98-90
www.aquaduna.org
info@aquaduna.com



AquaDuna GmbH & Co KG
Cleaning Technology
Automation Electronics
Mechatronics
Medical Technology



Paul-Kieselmann-Str. 4-10
75438 Knittlingen, Germany
Telefon +49 (0)70 43 371-0
Fax +49 (0)70 43 371-125
www.kieselmann.com
info@kieselmann.de



KIESELMANN GmbH
Innovative, reliable Valves
Process Components & Fittings
Beverage Tubes
Units

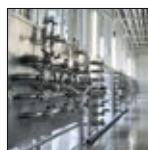

KIESELMANN Anlagenbau GmbH
Planning and Engineering
CIP-Plants
Flash Pasteurizers
Pigging Technology
Process Automation



Lautlinger Weg 3
70567 Stuttgart (Möhringen), Germany
Telefon +49 (0)711 7 67 26 60
Fax +49 (0)711 7 67 26 69
www.va-group.de
info@va-group.de



VA Food Processing GmbH
Planning and Engineering
for Food and Dairy Process Technology
Membrane Filtration
Process Automation



Rötestraße 19
74321 Bietigheim-Bissingen, Germany
Telefon +49 (0)71 425 81-0
Fax +49 (0)71 425 81-99
www.rieger-behaelterbau.de
info@rieger-behaelterbau.de



RIEGER Behälterbau GmbH
Stainless Steel Tanks
Manufacturing of Machinery
Agitated Vessels
Juice Complete-Extractors

The Division Managers of the company AquaDuna GmbH & Co. KG are at your service should you have any questions:

Sales

Technical Consultant Cleaning Technology

Michael Kottysch

Mobile: +49 (0)174 929 5812

E-Mail: michael.kottysch@aquaduna.com

Sales

Technical Consultant Cleaning Technology

Maximilian Rother

Mobile: +49 (0)172 362 0071

E-Mail: maximilian.rother@aquaduna.com

