



KIESELMANN

FLUID PROCESS GROUP

Translation of the original

Operating Instructions

Bunging valve

Type: 6254 - 6255

spring loaded
for steam and gas



KIESELMANN GmbH

Paul-Kieselmann-Str. 4-10
D - 75438 Knittlingen

 +49(0) 7043 371-0 •  +49(0) 7043 371-125
www.kieselmann.de • info@kieselmann.de

Copyright: © KIESELMANN FLUID PROCESS GROUP

Table of contents

1	General informations	4
1.1	Informations for your safety	4
1.2	Marking of security instructions	4
1.3	General designated use	4
1.4	Personnel	4
1.5	Modifications, spare parts, accessories	5
1.6	General instructions	5
2	Safety instructions	6
2.1	Intended use	6
2.2	General notes	6
2.3	General safety instructions	6
3	Delivery, transport and storage	7
3.1	Delivery	7
3.2	Transport	7
3.3	Storage	7
4	Function and operation	8
4.1	Description of function	8
4.2	Manual operation	8
4.3	Pressure setting	8
5	Commissioning, service and maintenance	9
5.1	Commissioning	9
5.1.1	Installation instructions	9
5.1.2	General welding guidelines	9
5.1.3	ATEX - Guidelines	9
5.2	Maintenance	9
5.3	Cleaning	10
6	Technical data	11
7	Disassembly and assembly	12
7.1	Disassembly	12
7.2	Assembly	13
8	Drawings and dimensions	14
8.1	Drawings	14
8.2	Dimensions	15
9	Wearing parts	16
10	Characteristic curves	17
10.1	Opening & closing characteristics	17
10.2	Performance chart	18
11	Appendix	21
11.1	Declaration of incorporation	21

1 General informations

1.1 Informations for your safety

We are pleased that you have decided for a high-class KIESELMANN product. With correct application and adequate maintenance, our products provide long time and reliable operation.





Before installation and initiation, please carefully read this instruction manual and the security advices contained in it. This guarantees reliable and safe operation of this product and your plant respectively. Please note that an incorrect application of the process components may lead to great material damages and personal injury.

In case of damages caused by non observance of this instruction manual, incorrect initiation, handling or external interference, guarantee and warranty will lapse!

Our products are produced, mounted and tested with high diligence. However, if there is still a reason for complaint, we will naturally try to give you entire satisfaction within the scope of our warranty. We will be at your disposal also after expiration of the warranty. In addition, you will also find all necessary instructions and spare part data for maintenance in this instruction manual. If you don't want to carry out the maintenance by yourself, our KIESELMANN - service team will naturally be at your disposal.

1.2 Marking of security instructions

Hints are available in the chapter "safety instructions" or directly before the respective operation instruction. The hints are highlighted with a danger symbol and a signal word. Texts beside these symbols have to be read and adhered to by all means. Please continue with the text and with the handling at the valve only afterwards.

Symbol	Signal word	Meaning
	DANGER	Imminent danger which will result severe personal injury or death.
	WARNING	Imminent danger which may result severe personal injury or death.
	CAUTION	Dangerous situation which may cause slight personal injury or material damages.
	NOTICE	An harmful situation which may result in damages of the product itself or of adjacent vicinity.
	INFORMATION	Marks application hints and other information which is particularly useful.

1.3 General designated use

The fitting is designed exclusively for the purposes described below. Using the fitting for purposes other than those mentioned is considered contrary to its designated use. KIESELMANN cannot be held liable for any damage resulting from such use. The risk of such misuse lies entirely with the user. The prerequisite for the reliable and safe operation of the fitting is proper transportation and storage as well as competent installation and assembly. Operating the fitting within the limits of its designated use also involves observing the operating, inspection and maintenance instructions.

1.4 Personnel

Personnel entrusted with the operation and maintenance of the tank safety system must have the suitable qualification to carry out their tasks. They must be informed about possible dangers and must understand and observe the safety instructions given in the relevant manual. Only allow qualified personnel to make electrical connections.

1.5 Modifications, spare parts, accessories

Unauthorized modifications, additions or conversions which affect the safety of the fitting are not permitted. Safety devices must not be bypassed, removed or made inactive. Only use original spare parts and accessories recommended by the manufacturer.

1.6 General instructions

The user is obliged to operate the fitting only when it is in good working order. In addition to the instructions given in the operating manual, please observe the relevant accident prevention regulations, generally accepted safety regulations, regulations effective in the country of installation, working and safety instructions effective in the user's plant.

2 Safety instructions

2.1 Intended use

The bunging valve is primarily intended to be used to hold the pressure of gaseous media in tanks and containers consistently and to prevent overpressure's if the safety function is set.

2.2 General notes



NOTICE - observe the operating instructions

To avoid danger and damage, the fitting must be used in accordance with the safety instructions and technical data contained in the operating instructions.



NOTICE

All data are in line with the current state of development. Subject to change as a result of technical progress.

2.3 General safety instructions



⚠ WARNING

Risk of injury by outflowing medium

Dismantling the valve or valve assemblies from the plant can cause injuries.

- Medias flowing through the leakage drain outlet are to be drained off without splashing into a discharge arrangement.
- Carry the disassembling only if when the plant has been rendered pressure-less and free of liquid and gas.



⚠ WARNING

ATEX - Guidelines

If the valve or the plant is operated in a potentially explosive atmosphere, the valid ATEX directive of the EC and the installation instructions in this operating manual must be observed.



⚠ WARNING

Risk of injury by outflowing medium

With pressure greater than the set pressure the gaseous or liquid media will radial escape into the atmosphere via outlet drillings.

- It is necessary to install protection and drainage devices.



⚠ CAUTION

Before starting the system, the entire pipeline system must be thoroughly cleaned.



⚠ CAUTION

Steps should be taken to ensure that no external forces are exerted on the fitting.

3 Delivery, transport and storage

3.1 Delivery

- Immediately after receipt check the delivery for completeness and transport damages.
- Remove the packaging from the product.
- Retain packaging material, or expose of according to local regulations.

3.2 Transport



CAUTION

Risk of injury and damage to the product

During the transport the generally acknowledged rules of technology, the national accident prevention regulations and company internal work and safety regulations must be observed.

3.3 Storage



NOTICE

Damage to the product due to improper storage!

Observe storage instructions
avoid a prolonged storage



INFORMATION

Recommendation for longer storage

We recommend regularly checking the product and the prevailing storage conditions during long storage times.

- To avoid damage to seals and bearings,
 - products up to DN 125 / OD 5 inch should be stored horizontally for maximum 6 months.
 - products larger than DN 125 / 5 inch, should be stored in the upright position with the actuator on top.
- Don't store any objects on the products.
- Protect the products for wetness, dust and dirt.
- The product should be stored in a dry and well ventilated room at a constant temperature (optimal indoor temperature: 25 C ±5; indoor humidity data 70% ±5%).
- Protect seals, bearings and plastic parts for UV light and ozone.

4 Function and operation

4.1 Description of function

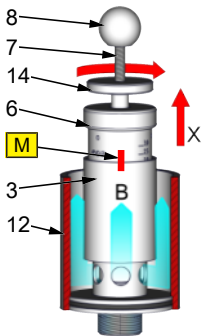

The bunging valve is used to prevent inadmissible overpressure of gaseous media in tanks, containers and plant sections. Generally, the set pressure is greater than the operating pressure. The valve opens against a spring force if the operating pressure increases to the set pressure. With pressure increase analogous to the opening characteristic, the flow volume is constantly conveyed depending on the max. permissible operating pressure.

To the visual control the glass cylinder (12) is filled with a liquid. Pressure excesses of gaseous condition media in the outlet opening "B" thereby get visible.

4.2 Manual operation

Manual operation

The manual lifting device serves to manually actuate the valve.

- Short term lifting of the valve takes place by pulling on the spindle (7) via the spherical button (8) and/or the lifting nut (14) in the direction X. This will raise the valve and the medium disperses via outlet B.
- For a longer lifting of the valve (e.g. when cleaning), the lifting nut (14) is turned in a clockwise direction to the adjusting nut (6). Now mark (M) the position with a pen/pencil. nscrew the adjusting nut (6) anticlockwise using 2 complete turns. The valve will be raised and the medium disperses via outlet B.

In order to close the valve, the adjusting nut (6) is turned in an anticlockwise direction using 2 complete turns as far as the mark. Screw the lifting nut (14) anticlockwise as far as the spherical button (8) and tighten.

4.3 Pressure setting

The set pressure can be adjusted by turning the adjustment nut (6) and can be read off about a scale on the adjustment nut (6).



INFORMATION

The positioning of the lifting nut (14) is tightened in the operating mode using the spherical button (8).

Were the lifting to come and rest upon the adjusting nut (6) the valve would not close tight enough to ensure a seal against the leakage.

5 Commissioning, service and maintenance

5.1 Commissioning

5.1.1 Installation instructions



Fitting position

The bunging valve must be installed vertically at connection "A" (see illustration).

Functional check

You should check for proper closing after installation by manually aerating the valve disk (2). Additionally, you should test for proper performance in the operating state according to the specified performance data.

5.1.2 General welding guidelines

Sealing elements integrated in weld components must generally be removed prior to welding. To prevent damage, welding should be undertaken by certified personnel (EN ISO 9606-1). Use the TIG (Tungsten Inert Gas) welding process.



CAUTION

Damage and injuries due to high temperature supply

To avoid a distortion of the components, all welding parts must be welded to stress-relieved. Allow all components to cool before assembling.



NOTICE

Damage due to impurities

Impurities can cause damage to the seals and seals area. Clean inside areas prior to assembly.

5.1.3 ATEX - Guidelines

For valves or plants/installations that are operated in the ATEX area, sufficient bonding (grounding) must be ensured (see valid ATEX Guidelines EG).

5.2 Maintenance



RECOMMENDATION

Replacement of seals

To achieve optimal maintenance cycles, the following points must be observed!

- When replacement of seals, all product-contacting seals should be replaced.
- Only original spare parts may be installed.

Maintenance interval

The maintenance intervals depend on the operating conditions "temperature, temperature-intervals, medium, cleaning medium, pressure and opening frequency". We recommend replacing the seals 1-year cycle. The user, however should establish appropriate maintenance intervals according to the condition of the seals.

Lubricant recommendation

	EPDM; HNBR; NBR; FKM; k-flex	- Klüber Paraliq GTE703*
	Silicone	- Klüber Sintheso pro AA2*
	Thread	- Interflon Food*
*) It is only permitted to use approved lubricants, if the respective fitting is used for the production of food or drink. Please observe the relevant safety data sheets of the manufacturers of lubricants.		

5.3 Cleaning**Cleaning**

The optimal cleaning is performed when the valve is opened. For this, open the valve with the manual lifting lever. (see Manual operation [▶ 8]).

6 Technical data

Valve size	DN 20	
Connection	<ul style="list-style-type: none"> • Thread RA 1 Inch DIN 11851 • Liner/nut DIN 11851 	
Temperature range	Ambient temperature: Operating temperature: Sterilization temperature:	+4 to +45°C (air) +0 to +95°C (medium dependent) EPDM +140°C (SIP 30 min)
Pressure range	0,2 - 2,2 bar 0,3 - 3,0 bar 1,1 - 3,2 bar	
Material: (in product contact)	Stainless steel:	1.4301 / AISI 304 1.4404 / AISI 316L
	Surfaces:	Ra ≤ 0,8µm e-polished
	Sealing material:	EPDM (FDA)

Setting range		
Item number	Working area	Opening-/ Permissible closing differential
6254 020 110 - xxx 6255 025 110 - xxx	0,2 - 2,2 bar	± 0,1 bar
6254 020 240 - xxx 6255 025 240 - xxx	0,3 - 3,0 bar	± 0,1 bar (>2 bar ± 0,2 bar)
6254 020 200 - xxx 6255 025 200 - xxx	1,1 - 3,2 bar	± 0,1 bar (>2 bar ± 0,2 bar)

7 Disassembly and assembly

7.1 Disassembly



NOTICE

All screw connections have right-handed threads.

Bunging valve with manual operation

- Evacuate the liquid from the glass cylinder.
- Slide glass cylinder (12) upwards from the tightly seat (1).

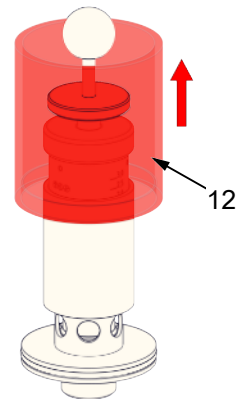
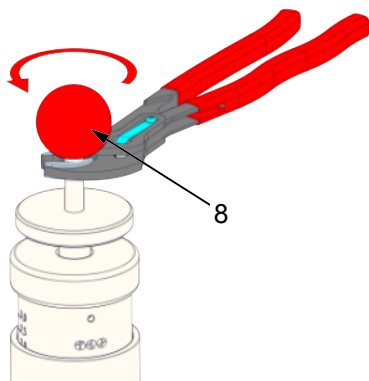

- Unscrew the spherical button (8).

- Unscrew spherical button (14).
- Unscrew adjustment nut (6). The tension from the pressure spring (9) is completely released.

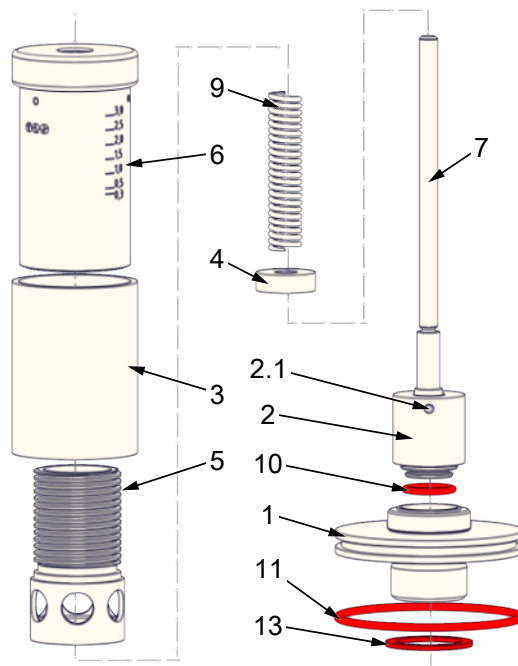
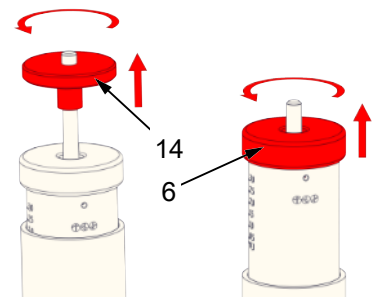

- Remove distance (3).
- Remove the pressure spring (9) and the spring disc (4).
- Unscrew the housing (5) from tightly seat (1).
- Remove the spindle (7) with valve disc (2).
- Remove O-ring (10), (11) and seal (13).

NOTICE! For bunging valves without manual operating, the dowel pin (2.1) and the lifting nut (14) are be dispensed with.

7.2 Assembly

Assembly

- Thoroughly clean and slightly lubricate mounting areas and running surfaces.
- Assemble in reverse order.



NOTICE

Alternately press and roll the O-ring (10) into the groove with round body.

Functional check

Check the function according to the specified performance data in the operating state.

8 Drawings and dimensions

8.1 Drawings

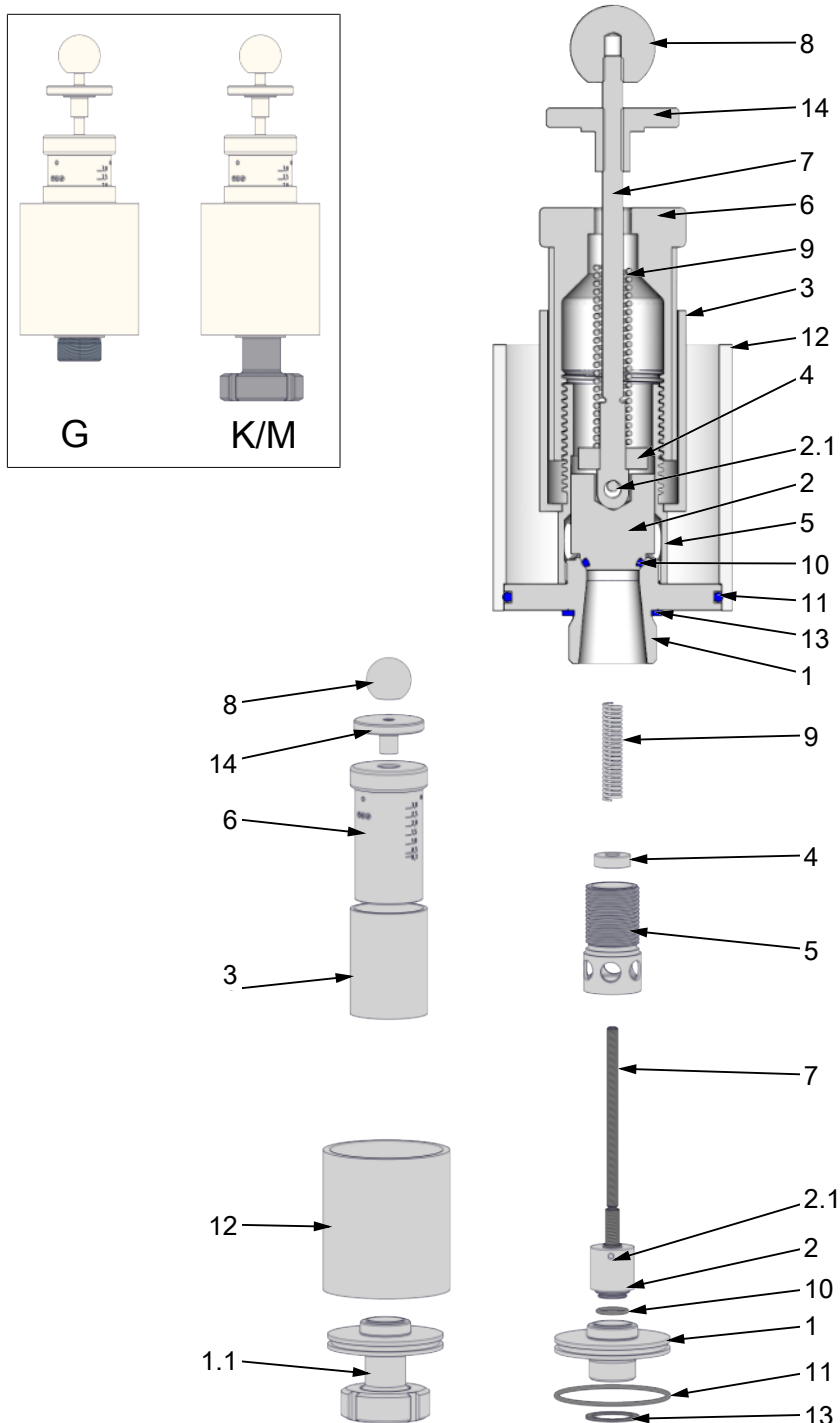

Fig. 1

1 Tightly seat -Thread	5 Housing	11 O-ring
1.1 Tightly seat -Liner/nut	6 adjusting nut	12 glass cylinder
2 Piston	7 Spindle	13 Seal
2.1 Dowel pin optional	8 spherical button	14 Lifting nut optional
3 Distance	9 Compression spring	
4 Spring disc	10 O-ring	

8.2 Dimensions

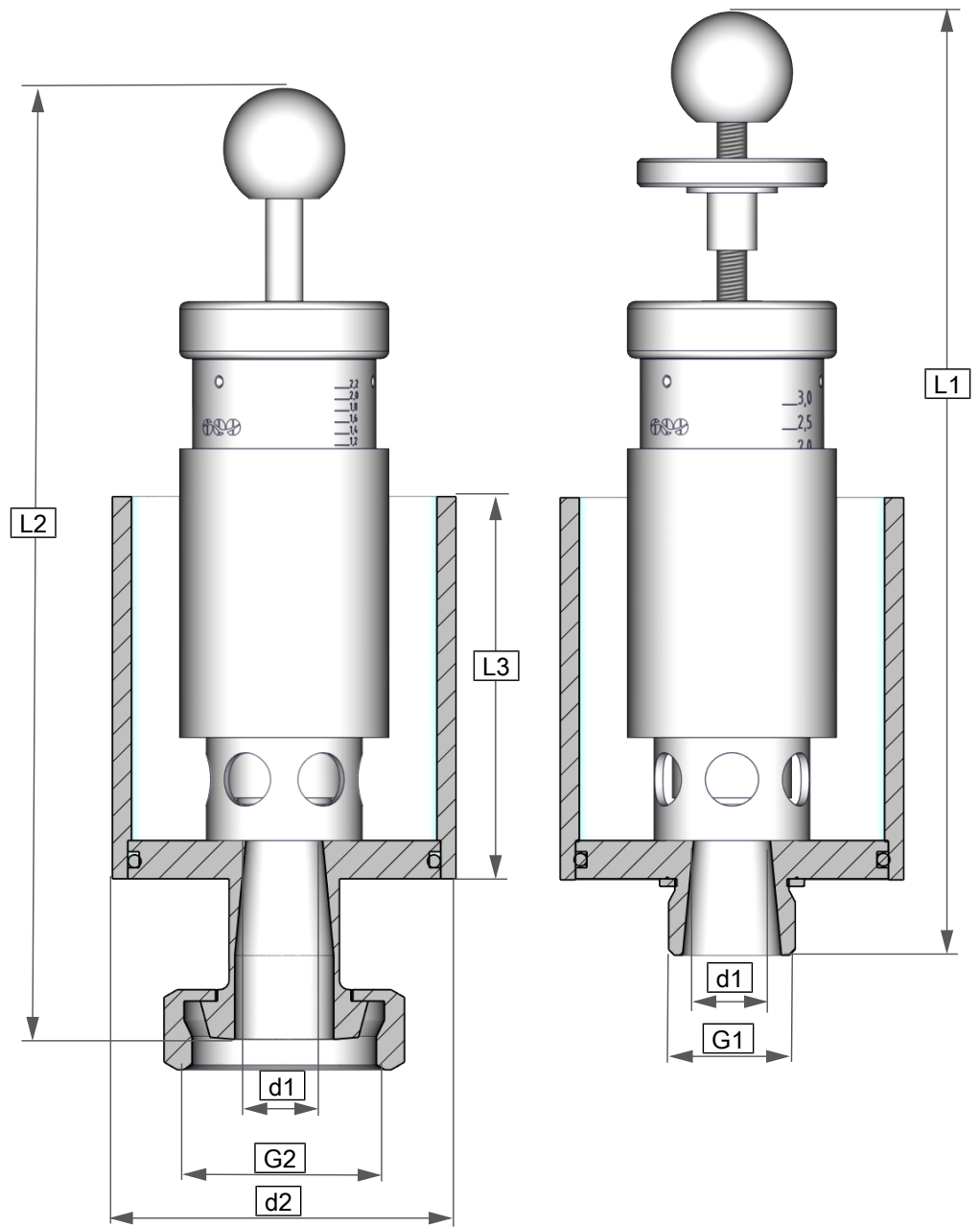

Fig. 2

Type	d1	d2	G1	G2	L1	L2	L3
6254, 6255	20	90	1	Rd 52x1/6	207 - 227	229 - 275	100

9 Wearing parts

Pos.	Designation	Material:	Item number
10	O-ring	EPDM	2304 015 030-086
11	O-ring	NBR	2304 070 035-055
12	glass cylinder	PMMA	6254 020 001-077
13	Seal	NBR	2353 038 029-077

10 Characteristic curves

10.1 Opening & closing characteristics

- Opening and closing characteristics for gas (air) 20°C

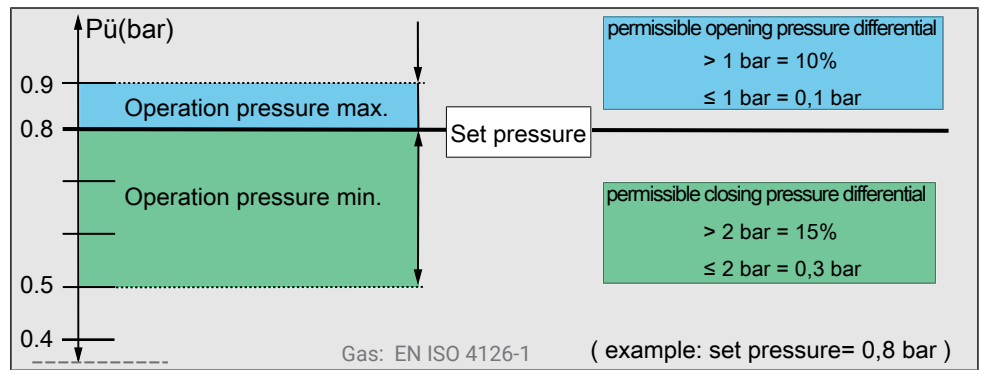
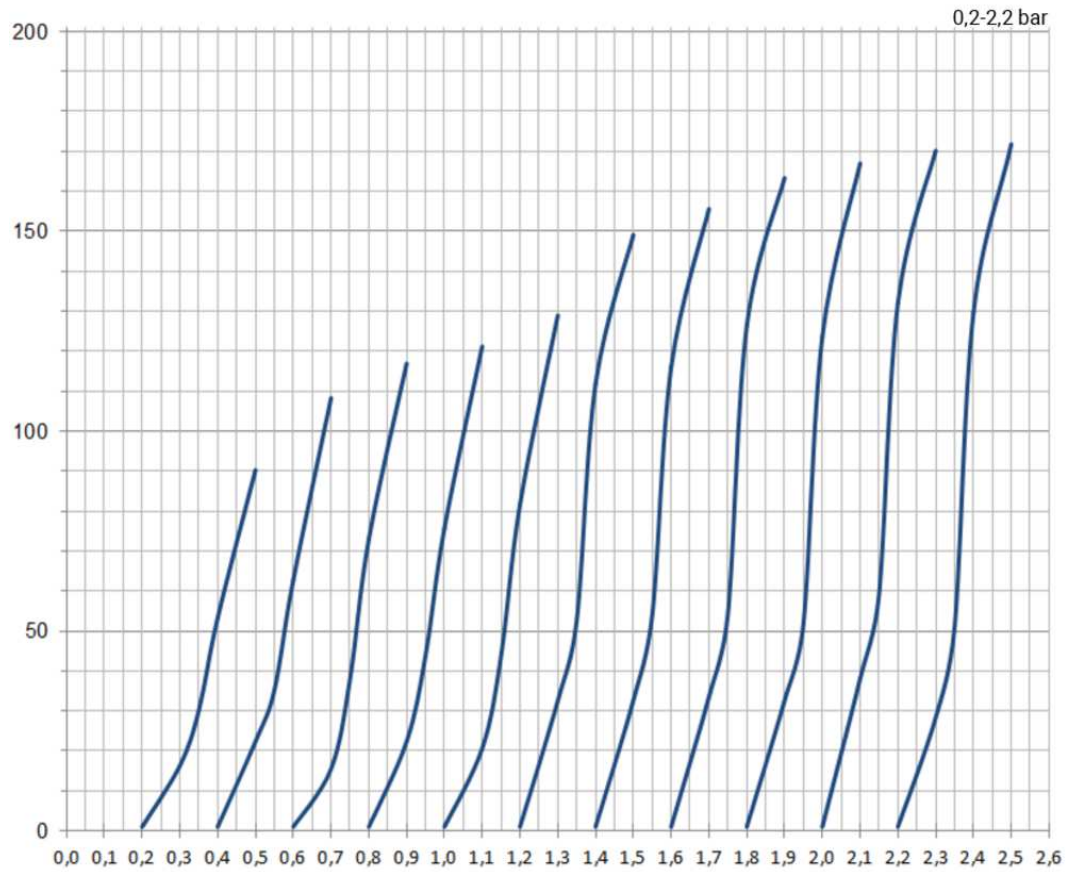

Fig. 3

10.2 Performance chart

Working area 0,2 - 2,2 bar

Set pressure bar	Closing pressure bar	Flow rate [m ³ /h] at set pressure			
		+0.1 bar	+0.15 bar	+0.2 bar	+0.3 bar
0.2	0.2	16.3	30.1	53.3	90.3
0.4	0.4	22.4	35.2	62.8	108.3
0.6	0.5	15.5	37.8	73.1	116.9
0.8	0.7	22.4	43.8	75.7	121.2
1.0	0.9	20.6	43.8	81.7	129.0
1.2	1.1	32.6	52.6	111.9	149.2
1.4	1.3	32.7	54.2	116.1	155.6
1.6	1.5	33.5	54.2	126.4	163.4
1.8	1.7	32.6	51.8	123.6	167.0
2.0	1.9	38.1	59.2	132.1	170.2
2.2	2.1	28.4	51.1	129.7	171.8



Working area 0,3 – 3,0 bar

Set pressure bar	Closing pressure bar	Flow rate [m ³ /h] at set pressure			
		+0.1 bar	+0.15 bar	+0.2 bar	+0.3 bar
0.3	0.25	22.8	33.4	47.5	61.3
0.5	0.4	24.1	35.0	50.3	73.4
1.0	0.9	32.9	44.6	55.8	89.3
1.5	1.4	39.0	50.5	63.9	104.2
2.0	1.9	63.4	80.8	107.7	126.7
2.5	2.3	64.9	85.5	116.0	148.0
3.0	2.8	97.4	122.2	139.6	151.4

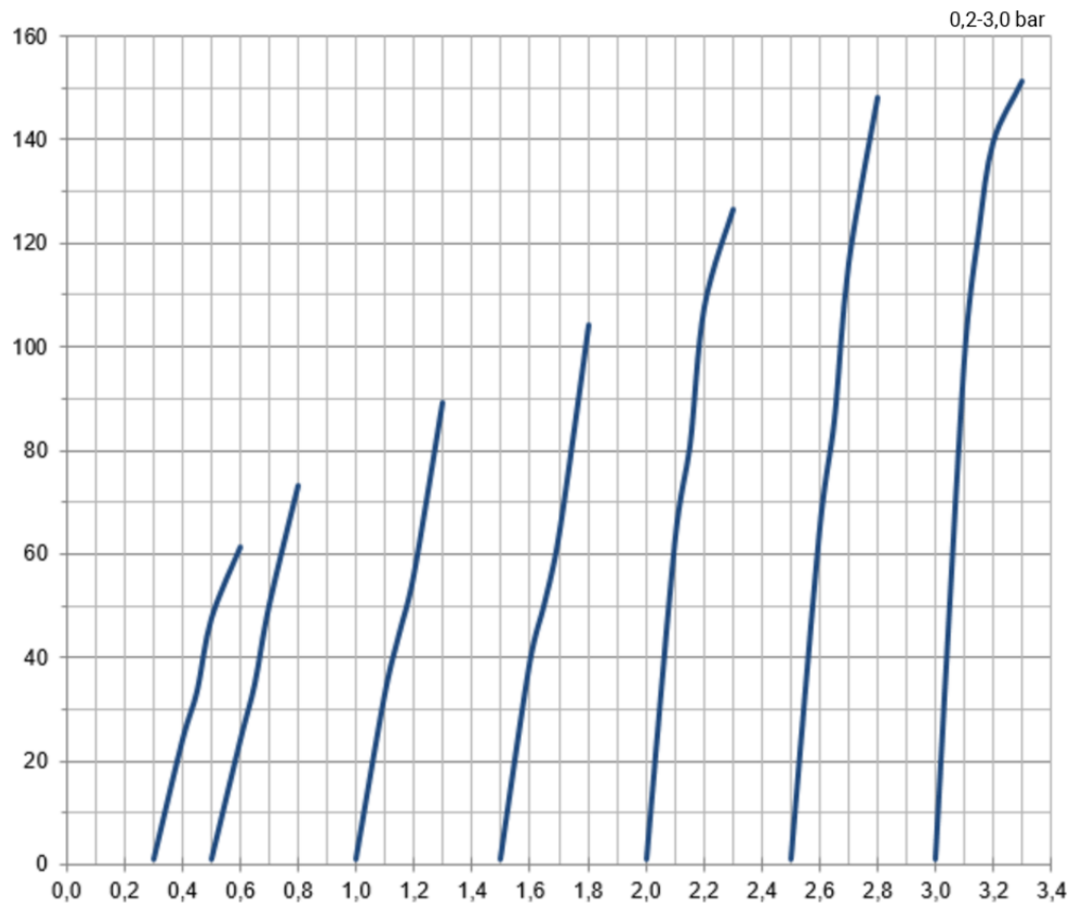

Working area 1,1 – 3,2 bar

Set pressure bar	Closing pressure bar	Flow rate [m ³ /h] at set pressure			
		+0.1 bar	+0,1,5 bar	+0.2 bar	+0.3 bar
1.1	1.0	31.8	46.4	96.3	137.6
1.5	1.4	29.2	86	118.6	155.6
2.0	1.9	37.8	68.8	140.1	168.5
2.5	2.4	19.2	125.3	140.3	182.9
3.2	3.1	137.6	153.0	168.4	205.5

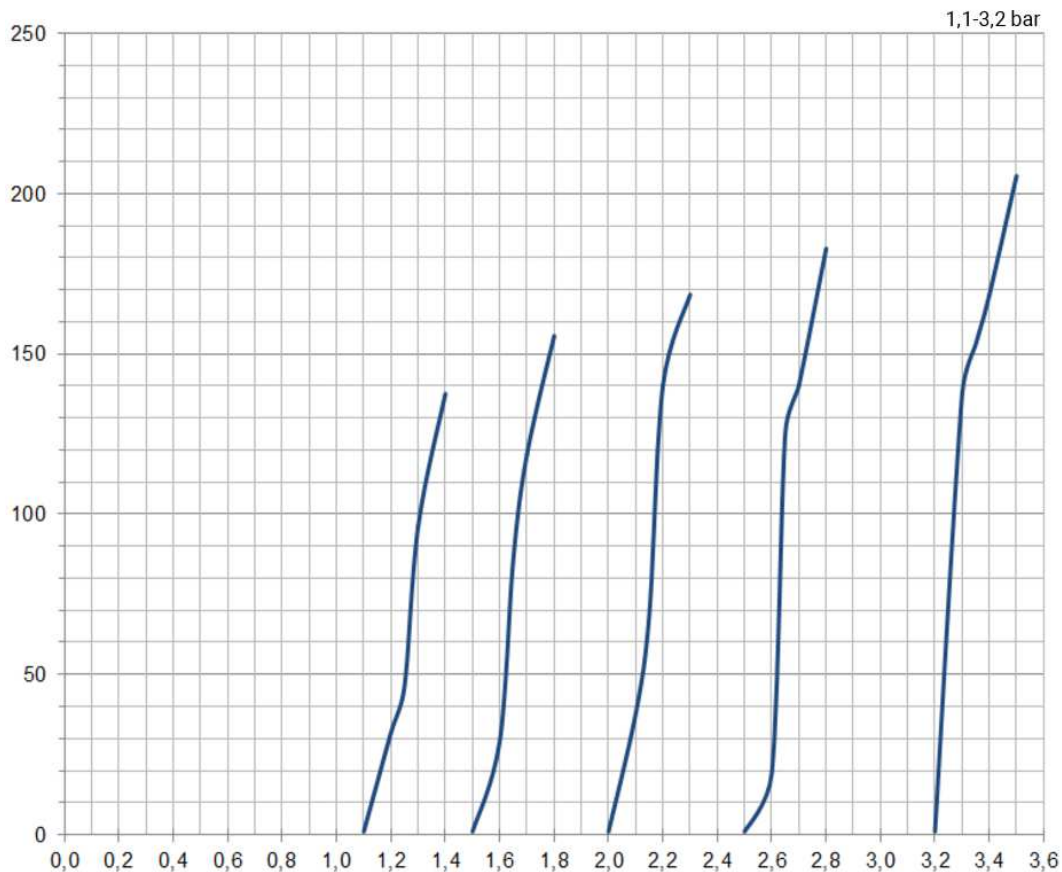

11 Appendix

11.1 Declaration of incorporation



Declaration of incorporation

Translation of the original

Manufacturer / authorised representative:

KIESELMANN GmbH

Paul-Kieselmann-Str. 4-10

75438 Knittlingen

Germany

Authorised representative:

(for compiling technical documents)

Achim Kauselmann

(Documentation / Development)

KIESELMANN GmbH

Paul-Kieselmann-Str. 4-10

75438 Knittlingen

Germany

<u>Product name</u>	<u>Function</u>
pneum. Lift actuators	Stroke movement
pneum. Rotary actuators	Rotary movement
Ball valves	Media cutoff
Butterfly valves	Media cutoff
Single seat valves	Media cutoff
Flow control valves	Control of liquefied media
Throttle valve	Control of liquefied media
Overflow valve	Definition of fluid pressure
Double seat valve	Media separation
Bellow valves	Sampling of liquids
Sampling valves	Sampling of liquids
Two way valves	Media cutoff
Tankdome fitting	Prevention of overpressure and vacuum, Tank cleaning
Safety valve	Prevention of overpressure

The manufacturer hereby states that the above product is considered as an incomplete machine in the sense defined in the Directive 2006/42/EC on Machinery. The above product is exclusively intended to be installed into a machine or an incomplete machine. The said product does not yet conform to all the relevant requirements defined in the Directive on Machinery referred to above for this reason.

The specific technical documents listed in Appendix VII, Part B, have been prepared. The Authorized Agent empowered to compile technical documents may submit the relevant documents if such a request has been properly justified.

Commissioning of an incomplete machine must not only be carried out if it has been determined that the respective machine into which the incomplete machine is to be installed conforms to the regulations set out in the Directive on Machinery referred to above.

The above product conforms to the requirements of the directives and harmonized standards specified below:

- Directive 2014/68/EU
- DIN EN ISO 12100 Safety of machinery

Knittlingen, 21.09.2017

i.V. Uwe Heisswolf
Head of Development

